

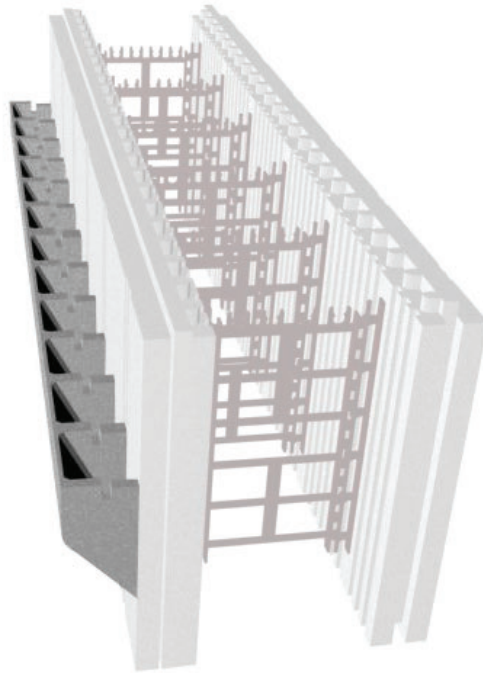

FRANSYL

IZOBEST® BRICK LEDGE

EXPANDED POLYSTYRENE INSULATED CONCRETE FORM ACCESSORY



IZOBEST®

INSULATED CONCRETE FORM - BRICK LEDGE

ADVANTAGES

- The thermal value of the expanded polystyrene is 100% guaranteed
- Shiplapped on four edges
- IZOBEST® particular interlocking system
- Invisible system attachment, high resistance to low temperature
- Durable concrete building
- Airtight
- Soundproofing (59 STC)
- Minimum of R-30
- Without thermal bridge
- Energy saving from 30% to 50%
- Meets Novoclimat requirements

ACKNOWLEDGMENT



PS 100%



LEED

TECHNICAL DATA

DIMENSIONS

IZOBEST® BRICK LEDGE

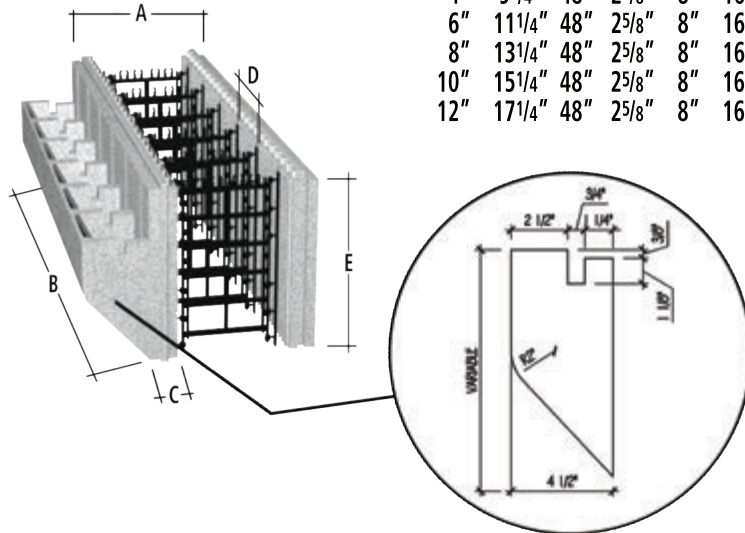

	A	B	C	D	E
4"	9 1/4"	48"	2 5/8"	8"	16"
6"	11 1/4"	48"	2 5/8"	8"	16"
8"	13 1/4"	48"	2 5/8"	8"	16"
10"	15 1/4"	48"	2 5/8"	8"	16"
12"	17 1/4"	48"	2 5/8"	8"	16"

IZOBEST® BRICK LEDGE	
Material	Panel: Moulded IZOLON expanded polystyrene (EPS) type HD
Block color	Grey

IZOBEST® BRICK LEDGE	
	HD (Type II)
Thermal resistance (ASTM C518 C177) 1" (25 mm) thickness	R-4,17 (RSI-0.73)
Water vapour permeability (ASTM E96), 1" (25 mm) thickness	2.25 perm (130 ng/Pa·s·m ²)
Compressive strength (ASTM D1621) 1 1/2" (38 mm) thickness	160 kPa * (23.3 lbs/in ²)
Flexural strength (ASTM C 203) 1 1/2" (38 mm) thickness	300 kPa (43.71 lbs/in ²)
Water absorption (ASTM D 2842) 1 1/2" (38 mm) thickness	3%
Density (ASTM D 1621)	1.5 lb/ft ³ (24.02 kg/m ³)
Limiting Oxygen Index (ULC S-701) % minimum	24%
Dimensional stability (ASTM D 2126) % maximum linear change	1.5%

* This result is based on in-house testing



INSULATED CONCRETE FORM SYSTEMS

T. 450.477.4423

1.800.363.2307

FRANSYL.COM